

NU TONE

BUILT-IN STEREO MUSIC SYSTEMS



NUTONE 4-WAY BUILT-IN DELUXE STEREO SYSTEM

1 the Amplifier

"HEART" OF THE NUTONE STEREO SYSTEM

Model 2401 Retail \$228.00

Dimensions 15¾" wide — 11" high — 4" deep

Note: No Speaker in Amplifier



Stereo FM Tuner 2

INCLUDES BUILT-IN MULTIPLEXER
ALSO FOR REGULAR FM and AM RADIO

Model N-2402 Retail \$245.90

Dimensions 15¾" wide — 11" high — 4" deep



3 Tape Recorder

"FOLD-IN WALL"

FITS INTO MODEL 2404 RECORD CABINET

Model 2405 Retail \$349.50

15¾" square — 4" deep



Record Changer 4

"FOLD-IN-WALL"

Model 2403 Retail \$120.00

Dimensions 15¾" square — 4" deep

RECORD STORAGE CABINET • Model 2404 — \$55.00

Holds up to 40 records in the right position for longer life. Cabinet is pre-wired for a Stereo Tape Recorder. Dimensions 15¾" square 4" deep.

1 Intercom . . . in a Stereo Amplifier! For music throughout the home, plus room-to-room communication . . . and door-answering. Luxury-listening for music and Intercom.

NuTone's Dual-Channel Amplifier accepts weak signals from any source such as tuner, phonograph, or tape and amplifies them without distortion hundreds of times, to give enough power for good listening-levels throughout the house. Provides treble and bass controls on both channels, so that highs and lows can be emphasized or de-emphasized according to listener's personal taste. Selector-switches for 8 stations. "On-Off" switch controls entire system. Power output: 30 w. Input 110-130 v. AC, 60 cycles, 95 w. 10 tubes: 6AV6, EZ81, 12AU7, 3-12AX7, 4-6AQ5.

2 Stereo-FM and FM/AM Radio Tuner for full Stereo in rooms equipped with two speakers, including new FM-Stereo broadcasts. Or you can have FM programs in some rooms, AM programs in others, simultaneously. Built-In Multiplexer, for FM-Stereo broadcasts. Finest selectivity, excellent channel separation, plus extremely high rejection of unwanted signals. High-Fidelity FM de-emphasis compensation . . . No drifting or fading. Transformer supply line has a line-voltage adjusting switch. 11 tubes: 6D10, 6BA6, 6BE6, EZ80, 6AL5, 2-6AU6, 2-6AV6, 2-6AB4. FM sensitivity: 3UV (20 db. quieting). Power switch controls Tuner only. A rich, hand-rubbed Walnut frame encloses the Gold Anodized Control-Panel. Power Input 42w.

3 A "Fold-In-Wall" Stereo Tape Recorder! Records and plays back 4-Track Stereo and monaural Tape with highest fidelity. Has built-in Preamplifiers. You can record favorite radio programs, phonograph records, Intercom conversations, family events . . . and play them back whenever you like. Also enjoy fabulous music pre-recorded on 4-Track Tape. Unit fits in NuTone's Model 2404 Record Storage Cabinet. (See description and price at bottom of opposite page); but is fully portable! Can be used in the field if a power supply is available. Two VU Meters, for accurate setting of recording levels. Record lock-position prevents accidental erasing of Tape. Two speeds, 7½ IPS and 3¾ IPS. Up to 7" reels. 60w.

4 Stereo Record Changer folds out for use, folds back in wall with positive safety for space-saving convenience. Plays all speeds of conventional records. Intermixes ten and twelve inch records of the same speed. Has Diamond stylus for Stereo and LPs, Sapphire for 78 RPMs. Last record can automatically shut off the entire system, or all but Intercom. The spring-loaded, vinyl-covered steel door prevents sudden impact in opening and closing. A snap-catch holds the playing-arm when the cabinet is closed. Positive grip-and-release qualities prevent records from hanging-up, or being released too soon. Power input: 110-130 volts AC, 60 cycle, 15 watts. The hand-rubbed Walnut frame matches other components.



▲ Tape Recorder and Amplifier; Stereo Speakers in wall.



▲ "4-Square" combination, using all four components.



▲ Tape Recorder, Amplifier and Stereo-FM Tuner.



▲ Stereo-FM Tuner, with Amplifier.

NuTone Coaxial Speakers



← WITH CONTROLS
Model 2411 Retail \$39.75
Dimensions 12 $\frac{7}{8}$ " square



WITHOUT CONTROLS →
Model 2412 Retail \$22.00
Dimensions 12 $\frac{7}{8}$ " square



Inside and Outside Remote Controls



← INSIDE
Model 2416
Retail \$29.75
Dimensions 12 $\frac{7}{8}$ " wide
4 $\frac{7}{8}$ " high



OUTSIDE
Model 2415 Retail \$24.75
Dimensions 13 $\frac{3}{8}$ " wide — 5 $\frac{1}{8}$ " high



Deluxe High Fidelity Speaker System →

Model 2419 Retail \$89.95

C



Door Speaker

Model 2413 Retail \$12.75
Dimensions 4 $\frac{5}{8}$ " wide — 6 $\frac{1}{8}$ " high

D

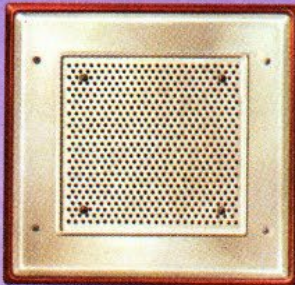

Patio Speaker

Model 2417 Retail \$17.25
Dimensions 13 $\frac{3}{4}$ " square

E

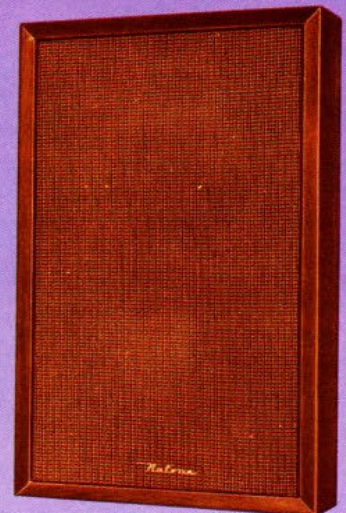

Dimensions
17 $\frac{3}{8}$ " wide, 28 $\frac{1}{8}$ " high, 4" deep

**CHOOSE THE ONE THAT SUITS YOUR PLANS;
ADD THE SPEAKERS YOU WANT TO EACH COMBINATION.**

A NuTone speakers use walls as enclosures for finest reproduction of sound. Volume for both speakers is regulated at the Speaker-With-Controls. These controls also turn off speakers, to allow a choice between two monaural programs in place of Stereo. The Speakers-With-Controls also contain Intercom-Switches, for room-to-room conversations and for door-answering. Use Model 2412 with Model 2411 to equip rooms for Stereo, or two Model 2412 plus Remote-Control, Model 2416, if speakers are mounted out of convenient reach. Use one Model 2411, or one Model 2412 plus Model 2416 in rooms equipped for monaural listening only. Speakers are 8" Coaxial Type with mechanical crossover and pre-wired harness. Mounting frames for "hands-free" wiring. Walnut frame. Anodized panel. Non-tarnish Grille.

B Remote-Controls for maximum operating convenience when speakers are mounted out of reach. Models for inside and outside use replace functions of Speakers-With-Controls, including Intercom-switch and Talk-Listen lever for door-answering. Inside Remote-Controls have Walnut frame, gold anodized panel. Match inside speakers. Remote-Controls for use with patio speakers have sealed housings. Recessed panels protect controls against weather and damage. Unit has a completely corrosion-proof finish.

C Door Speakers are scientifically designed with concave grille to permit clear "pick-up" of normal voice-levels. No shouting. All calls are controlled from inside speakers. No need for a Talk-Listen lever at the Door Speaker. Conversations can be originated and terminated at any inside Speaker-With-Controls or any Remote-Control panel. Door Speakers mount easily in a wall, ceiling, or soffit. Can also act as "Night-Watchman" by using any inside Speaker-With-Controls as a "listening-post" to alert the homeowner to disturbing sounds outside the house. Housing is sealed against moisture. Corrosion-proof Aluminum in Gold Anodized finish.

D Patio Speakers lend glamor to outdoor-living, provide added enjoyment to extra hours of relaxation. Weatherproof Aluminum — protects against rust, stain and tarnish. Outside Remote-Controls, Model 2415, permit Patio Speakers to be mounted out of reach and to operate the same as inside speakers, including Intercom to and from the house, plus door-answering from the Patio. Moisture-resistant 8" Coaxial type, with mechanical crossover. Use 2 for Stereo, one for monaural, plus remote-control.

E The ultimate in High-Fidelity Speakers. Achieves the fullest benefit of the Stereo Amplifier and the NuTone Tape Recorder. Each unit consists of one 12" woofer with oversize one-pound magnet and two 3 1/2" tweeters mounted in a cabinet which matches other units in the NuTone Stereo Music System. Use 2 for Stereo, one for monaural listening. Control with Remote-Control #2416.

NOTE: The NuTone Stereo system can be wired for remote phono inputs, which enables you to play a phonograph anywhere in the house throughout the system.

NuTone Deluxe Stereo System Speakers and Components cannot be used with NuTone Transistor Stereo System or NuTone Intercom-Radio Systems

- Combination A:** Built-In Stereo Record Changer, Amplifier-Intercom. Model Nos. 2401 and 2403 plus speakers.
- Combination B:** Built-In Stereo Record Changer, Stereo FM, FM & AM Tuner, Amplifier-Intercom. Model Nos. 2401, N-2402, 2403 plus speakers.
- Combination C:** Built-In Stereo Record Changer, Stereo FM, FM & AM Tuner, Amplifier-Intercom, Record Storage Cabinet. Model Nos. 2401, N-2402, 2403, 2404 plus speakers.
- Combination D:** Built-In Stereo Record Changer, Stereo FM, FM & AM Tuner, Amplifier-Intercom, Stereo Tape Recorder. Model Nos. 2401, N-2402, 2403, 2404 and 2405 plus speakers.
- Combination E:** Built-In Stereo FM, FM & AM Tuner, Amplifier-Intercom. Model Nos. 2401 and N-2402 plus speakers.
- Combination F:** Built-In Stereo FM, FM & AM Tuner, Amplifier-Intercom, Stereo Tape Recorder. Model Nos. 2401, N-2402, 2404, 2405 plus speakers.
- Combination G:** Built-In Amplifier-Intercom, Stereo Tape Recorder. Model Nos. 2401, 2404, 2405 plus speakers.

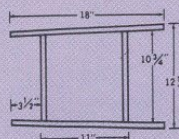

Models 2411-A and 2412-A Rough-in Box

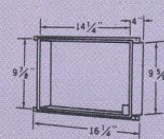

Model 2401-A and 2402-A Rough-in Box

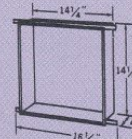

Model 2403-A and 2404-A Rough-in Box

Dimensions for Major Components, Speakers and Remote-Control Panels.

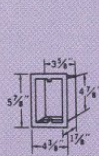

Model 2006-A Rough-in Box (Use with 2413-B)

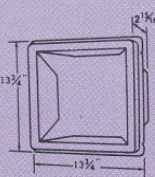

Model 2414-A Rough-in Box

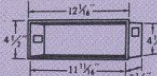

Model 2415-A and 2416-A A-Unit Rough-in Box

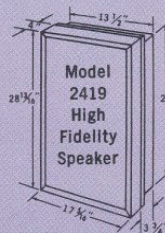

ALSO AVAILABLE BUT NOT SHOWN

- Model 2421 • 50 feet 8 conductor wire 5.95
- Model 2422 • 60 feet 2 conductor wire 1.80
- Model 2424 • 250 feet 8 conductor wire 17.50
- Model 2420 • FM Antenna—Includes mounting brackets, straps, mast, insulators and 50' lead-in wires 11.95

NOW . . . Door Chime Signals Throughout The House with NUTONE'S

Electronic Door Chimes



L-70 SURFACE MOUNTED "ELECTRONIC" DOOR CHIME
Retail Price \$38.95



L-72 "ELECTRONIC BUILT-IN DELUXE" DOOR CHIME
Retail Price \$46.95

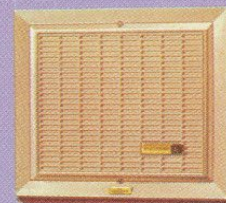

L-73 "ELECTRONIC BUILT-IN" DOOR CHIME
Retail Price \$18.95

NuTone Electronic Chimes connect with All NuTone Stereo-Intercom or Intercom-Radio Systems . . . Relays chime tones into rooms with speakers. Have volume control. Can be heard above music or Intercom in all rooms. Can be heard as a regular Chime when Stereo or Intercom system is turned off. Electronic mechanism installed in cabinet or housing. Transformer included with each chime.

L-70 Adjustable for 8 or 4 notes at front door, one note rear door, different note for 3rd door. Walnut or Lime Oak finish cover — Gold Anodized Grille. 7 3/4" x 11 1/4" x 3 3/8".

L-72 Adjustable for 8 or 4 notes for the front door, 1 note rear door, different note for 3rd door. Has Walnut finish frame, gold flecked grille cloth and gold Anodized panel with control knobs . . . matches NuTone Stereo-Intercom system speakers. 9" wide, 10 1/2" high. Cutout 7 1/8" wide, 9 1/8" high. Housing 3 3/8" deep.

L-73 Light Beige finish plastic cover with Gold trim and modernistic grille. Sounds two notes for front door, one note for rear door. Transformer included. Cover is 9" x 8". Housing 2" deep. Cutout for housing 6 7/8" square. Contains knockouts for Thin Wall Conduit.

NEW

NuTone Built-In...

Amplifier - Stereo FM Tuner*

FULLY TRANSISTORIZED! EXCLUSIVE
NEW "STEREO-STATION LOCATOR"!

Model 2071 Retail \$347.00
Dimensions: 15¾" wide — 9½" high — 3⅞" deep

Now . . . a Transistorized Tuner-Amplifier for Stereo-FM, FM or AM music, plus Intercom! Ten Selectors for inside and outside speakers. Finest Stereo and monaural listening; room-to-room Intercom, plus door-answering from any speaker. Built-In Multiplexer. Exclusive "Stereo-Station Locator" quickly selects stations broadcasting full-Stereo programs. 24 transistors; 14 diodes; AFC; power output 10 watts per channel. Input 110-130 volts AC, 60 cycles, 15 watts. Walnut Frame. Gold finish control-panel.

Note: No Speaker in Amplifier - Tuner.

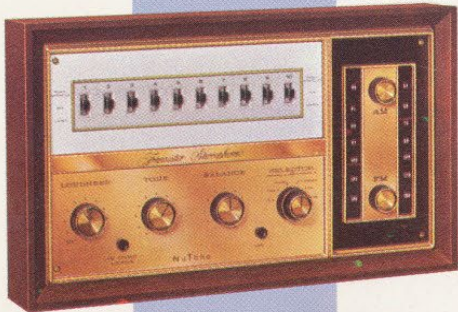

Tape Recorder*

"Fold-In-Wall"

FITS INTO MODEL 2074 RECORD STORAGE CABINET

Model 2405 — Retail \$349.50 (not including cabinet)
Dimensions: 13" wide x 7" high x 12" deep (in playing position)

Plays back and records 4-Track Stereo and monaural Tape with highest fidelity. Built-In Preamplifiers. DC filaments for low hum. Record favorite radio programs, phonograph records, family events and play them back! Enjoy fabulous music pre-recorded on Tape! Unit fits into Model 2074 Record Storage Cabinet, but is portable. Two VU Meters for accurate setting of recording levels. "Record-Lock" prevents accidental erasing of Tape. Speeds: 7½ IPS and 3¾ IPS. Up to 7" reels. Power input 110-130 volts AC, 60 cycles, 60 watts. Tubes: 4-12AX7, 1-12AU7.

RECORD STORAGE CABINET • Model 2074 — \$54.00



Record Changer*

"FOLD-IN-WALL"

Model 2073 Retail \$99.75
Dimensions: 15¾" square — 4" deep

Mono-Stereo Hi-Fidelity Record Changer folds out for use; folds back in wall with positive safety for space-saving convenience. Plays all speeds of conventional records. Intermixes ten and twelve inch records of the same speed. Has Diamond stylus for Stereo and LPs; Sapphire for 78 RPMs. A snap-catch holds the playing-arm when cabinet is closed. Positive grip-and-release qualities. Records won't hang-up or release too soon. Power input: 110-130 volts AC, 60 cycle, 15 watts. Walnut Frame.

* Fits into standard 2" x 4" wall. • Available March 15, 1964



... Transistor Stereo



Major components are built-in to the wall. Record Changer and Tape Recorder fold away when not in use. Stereo Speakers can be installed in every room.

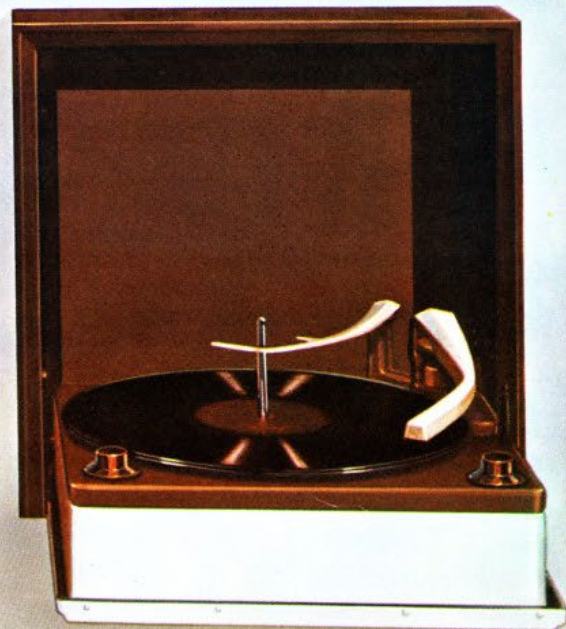

View of a typical room, with Speakers built-in to wall.



Many arrangements of Stereo components can be made to suit your taste.

NuTone Wall Speakers

for
FINEST STEREO
and
MONAURAL
LISTENING!



(A) 8" Inside Speaker Model 2081
(With Controls) 12 $\frac{3}{4}$ " x 12 $\frac{1}{4}$ "

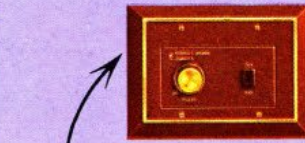
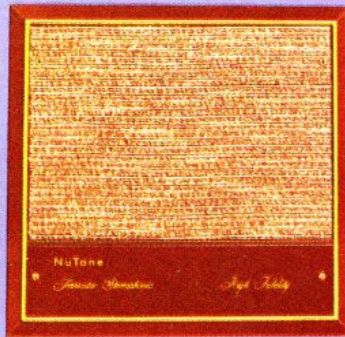

"Break-Away" Remote
Control Included
with Model 2081
6 $\frac{5}{8}$ " x 5"



Remote Control
Included with
Model 2084 6 $\frac{5}{8}$ " x 5"

(D) Door Speaker
Model 2006
4 $\frac{3}{4}$ " x 5 $\frac{7}{8}$ "



(B) 8" Inside Speaker
(Without Controls)
Model 2082
12 $\frac{3}{4}$ " x 12 $\frac{1}{4}$ "

(C) 8" Patio Speaker
(With Controls) Model 2084
13 $\frac{3}{4}$ " x 13 $\frac{3}{4}$ "

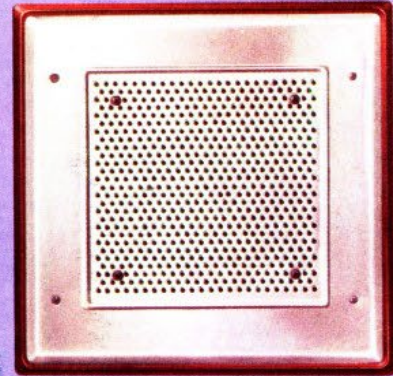

Patio Speakers install inside, in ceiling or wall,
with #2411-A frame; "disappear" by painting or
papering over Grille. (Punch out holes.)
Mount Remote-Controls anywhere, in standard wall-box.

(A) 8" INSIDE SPEAKER (With "Break-Away" Controls) — Model 2081

Gives you Stereo plus Intercom when used with Model 2082 in the same room; or high-fidelity, monaural music plus Intercom when used alone. Coaxial rotary volume controls for both channels; exclusive Talk-Listen button for Intercom and door-answering. Privacy-setting prevents eavesdropping. The "break-away" panel removes for mounting as a separate Remote Control. Includes snap-in panel to replace it on speaker, plus a bezel for mounting Controls in standard 3-gang wall box, as a Remote Control unit. New ceramic magnet. Has Grille cloth; Walnut brown frame. **Retail \$29.75**

(B) 8" INSIDE SPEAKER (Without Controls) — Model 2082

For use with Model 2081 in rooms equipped for Stereo listening. It operates from the coaxial controls furnished with #2081. Attractive Frame. Fabric Grille cloth. **Retail \$19.25**

5" INSIDE SPEAKER Model 2027 (Not Shown)

Rotary Control for music and Intercom volume. Exclusive Talk-Listen button for Intercom and door-answering. For rooms equipped for monaural listening, where Intercom is primarily desired. Desert Sand. **Retail \$8.50**

(C) 8" OUTSIDE PATIO SPEAKER (With Controls) — Model 2084

Includes a Stereo Remote Control Unit with coaxial controls for both channels. It mounts in standard 3-gang wall box, or in a #2013A unit; permits speaker to be mounted out of reach. Exclusive Talk-Listen button for Intercom and door-answering from the Patio. Both the Grille and the Speaker are completely weatherproof. **Retail \$28.75**

8" OUTSIDE PATIO SPEAKER (Without Controls) — Model 2085 (Not shown)

Same as Model 2084, but without a Remote-Control Unit. For use with #2084 for Stereo. Operates from controls furnished with #2084. **Retail \$17.25**

(D) DOOR SPEAKER — Model 2006

Answer the door from Inside or Patio Speakers; check on children's outside activities; use as a "Nightwatchman"! "Talk-Listen" Switch; Gold Anodized; weatherproof. (Not designed for music.) **Retail \$7.50**

These NuTone Transistor Stereo System Speakers cannot be used with NuTone's Deluxe Stereo System or #2500 Series Transistorized Intercom-Radio System.

Combinations Possible With NuTone's Transistor Stereo

- Combination 1 — Built-in Tuner-Amplifier, Record Player, and Tape Recorder. (Models 2071, 2073, 2074, 2405)
- Combination 2 — Built-in Tuner-Amplifier, Record Player, and Record Storage Cabinet. (Models 2071, 2073, 2074)
- Combination 3 — Built-in Tuner-Amplifier, and Tape Recorder. (Models 2071, 2074, 2405)
- Combination 4 — Built-in Tuner-Amplifier, and Record Player. (Models 2071, 2073)

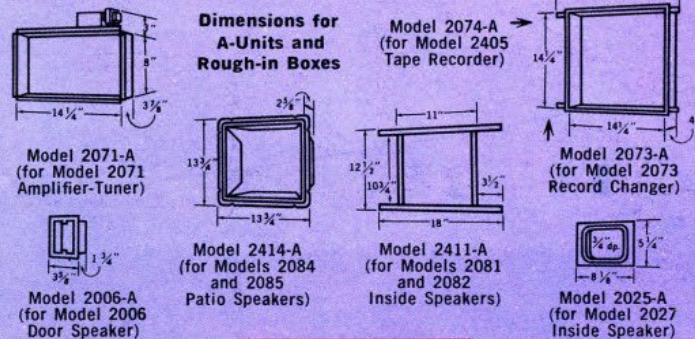

ALSO AVAILABLE BUT NOT SHOWN

- Model 2078 — 200 ft. flat 5 conductor wire. Color coded **\$11.50**
- Model 2079 — 1000 ft. flat 5 conductor wire. Color coded **\$51.75**
- Model 2420 • FM Antenna — Includes mounting brackets, straps, mast, insulators and 50' lead-in wires **\$11.95**

Prices Higher Outside Continental United States.
Prices subject to change without notice.

See page 4 for NuTone Electronic Door Chimes.

NUTONE INCORPORATED

Madison and Red Bank Roads, Cincinnati 27, Ohio.

Copyright 1964 by NuTone, Inc. S-505 Printed in U.S.A.